



**Internationales Fahrturnier
International Driving Event
CAI 3*/CAI 2*
Nationales Fahrturnier
CAN**

09.04.-12.04.2026

**Liebe Teilnehmer/innen,
Herzlich Willkommen zum diesjährigen Fahrturnier
beim
„Fahr - und Reitverein Wettringen“.
Getreu unserem Motto
„Turnier von Fahrern für Fahrer“
wünschen wir Euch viel Erfolg und vor Allem viel
Spaß!**

**Dear participants,
Welcome to this year's driving competition at
„Fahr - und Reitverein Wettringen“.
True to our motto
"Tournament by drivers for drivers"
we wish you success and above all a lot of fun!**

Teilnehmerunterlagen Competitorsmap





**Internationales Fahrturnier
International Driving Event CAI 3*/CAI 2*
Nationales Fahrturnier CAN**

09.04.-12.04.2026

WarmUpTrack

(Recommended for all international classes)

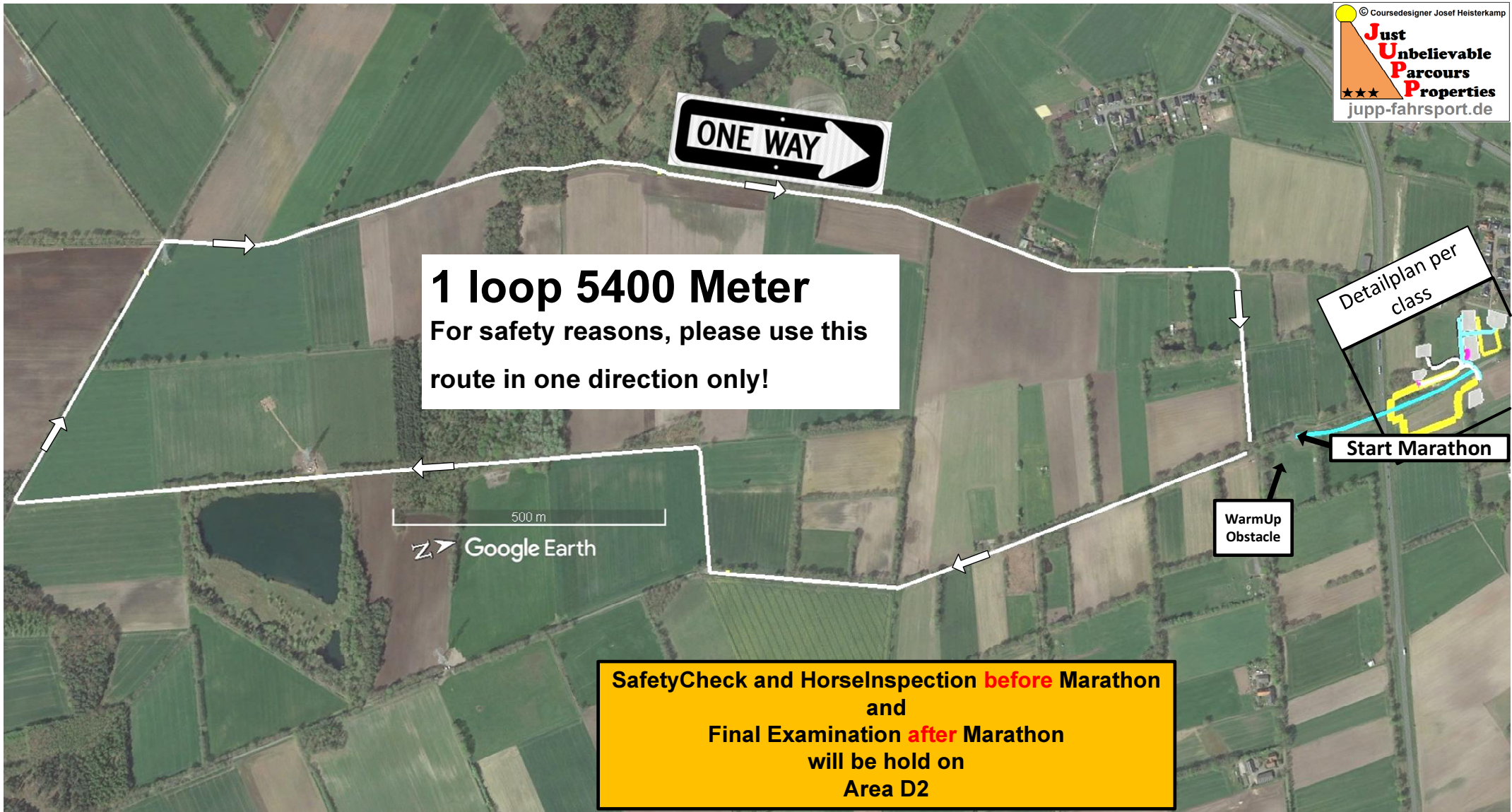



Internationales Fahrturnier International Driving Event CAI 3*/CAI 2* Nationales Fahrturnier CAN

09.04.-12.04.2026

Marathon 2* 4830 Meter

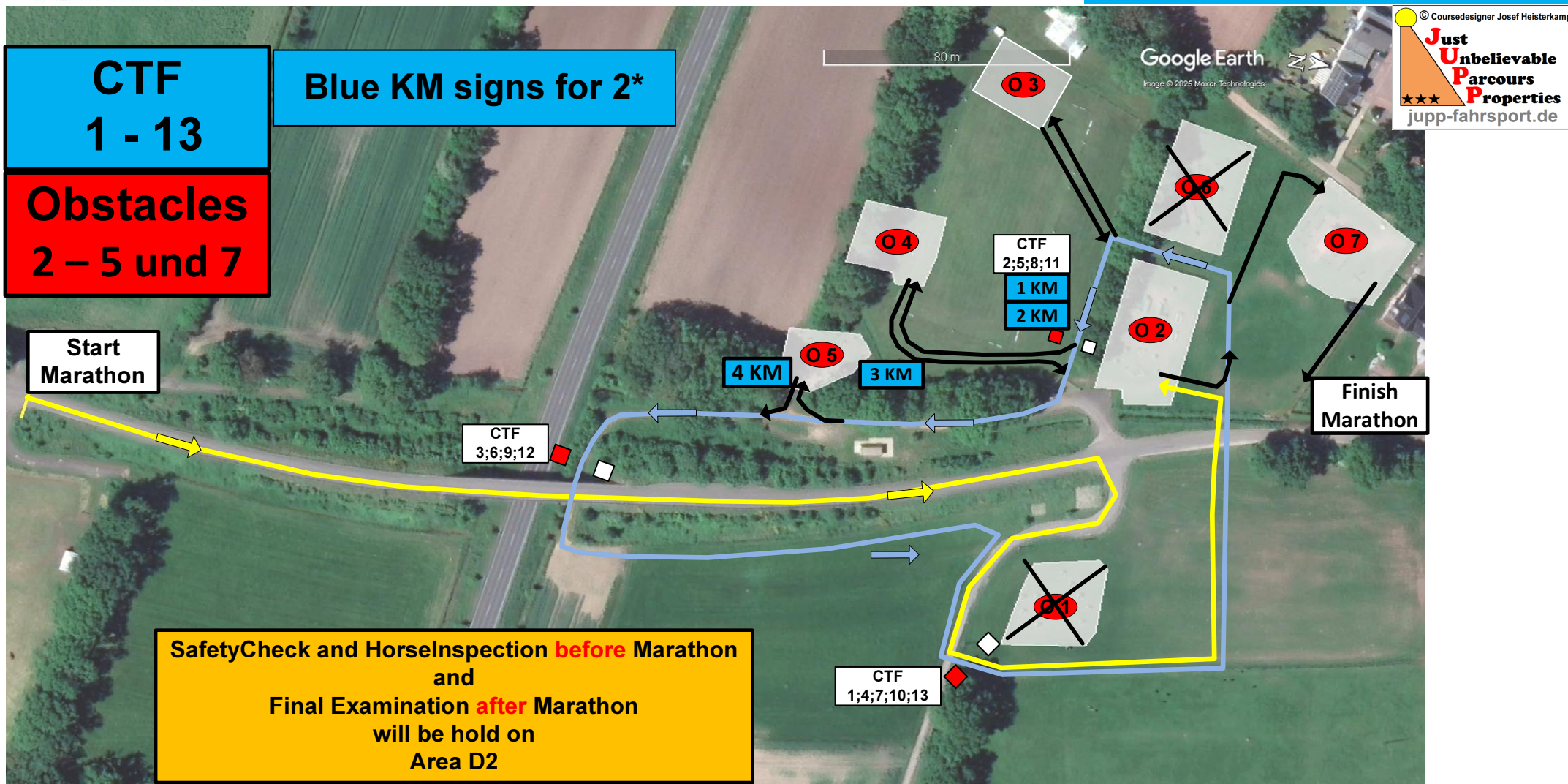

Legende: Start Marathon / CTF1 / O2 / CTF2 / 1 KM / CTF3 / CTF4 / O3 / CTF5 / 2 KM / CTF6 / CTF7 / CTF8 / O4 / 3 KM / CTF9 / CTF10 / CTF11 / O5 / 4 KM / CTF12 / CTF13 / O7 / Finish Marathon. 4830 Meter



Internationales Fahrturnier
 International Driving Event
 CAI 3*/CAI 2*
 Nationales Fahrturnier
 CAN
 09.04.-12.04.2026

Times Marathon Geländezeiten

CAI 2* H1 HORSES Comp. Nr.: 10	Länge in Meter	Tempo KM/h	Minimum Time h:min:sec	Time allowed h:min:sec	Maximum Time h:min:sec	Compulsory Turning Flags/ Pflichttore	Obstacles
Marathon Phase	4830	13	00:19:18	00:22:18	00:44:35	CTF 1-13	2; 3; 4; 5; 7
CAI 2* P1/P2 PONYS Comp. Nr.: 2 / 6	Länge in Meter	Tempo KM/h	Minimum Time h:min:sec	Time allowed h:min:sec	Maximum Time h:min:sec	Compulsory Turning Flags/ Pflichttore	Obstacles
Marathon Phase	4830	12	00:21:09	00:24:09	00:48:18	CTF 1-13	2; 3; 4; 5; 7



Internationales Fahrturnier
International Driving Event
CAI 3*/CAI 2*
Nationales Fahrturnier
CAN
09.04.-12.04.2026

Hindernis
Obstacle **2**

Powered by:



CAI 3*

CAI 2*

Wall

Geländefahren Kl. M Prfg.Nr: 40 nur

Tore A-E

Nicht für Kl.A!

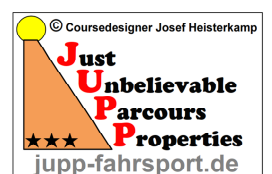
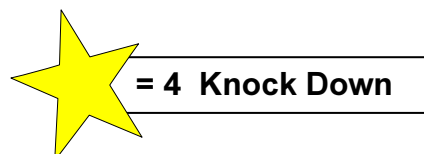
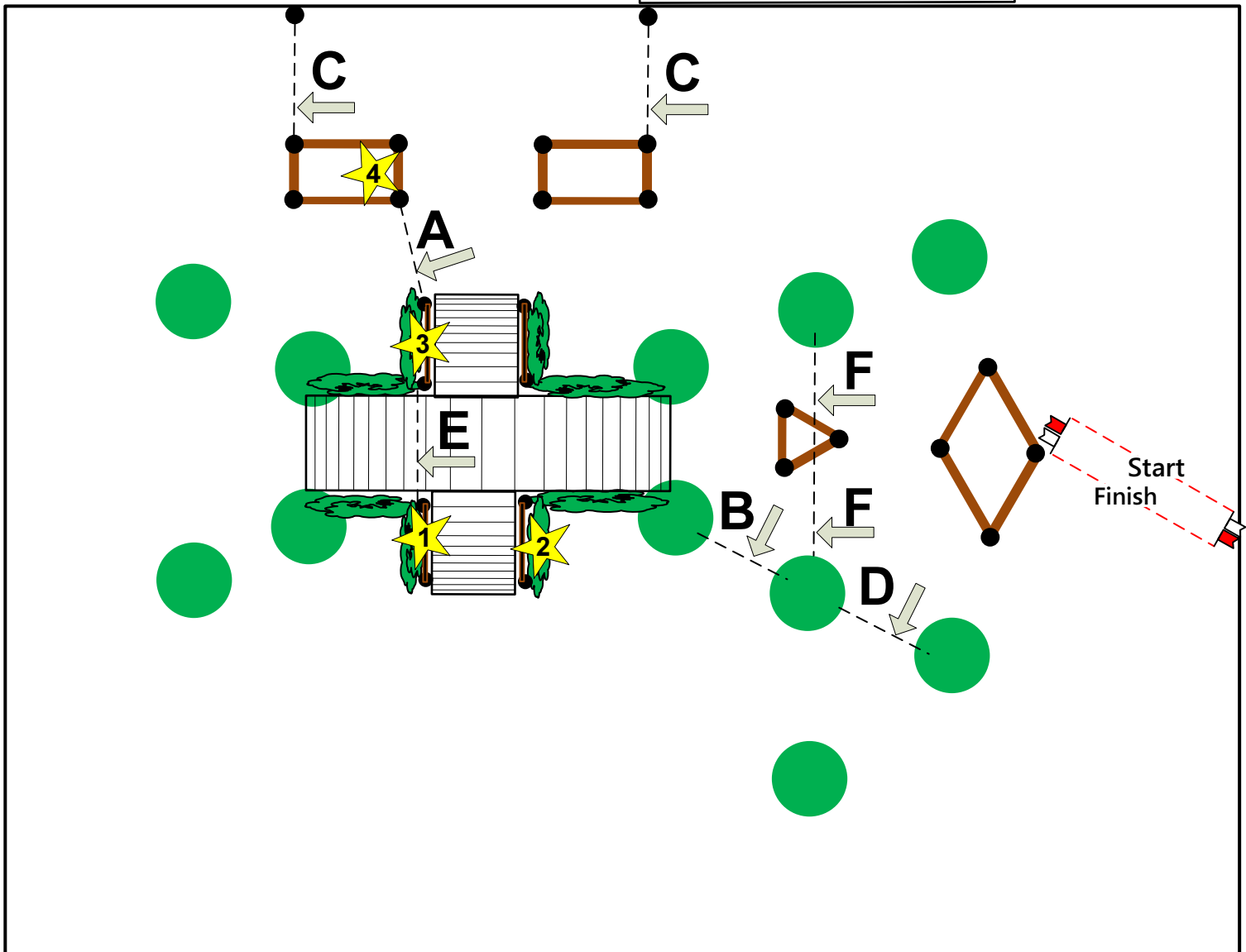



Internationales Fahrturnier
 International Driving Event
 CAI 3*/CAI 2*
 Nationales Fahrturnier
 CAN
 09.04.-12.04.2026

Hindernis
Obstacle **3**

Powered by:

Meister
Schophuis
 Zimmerei Dachdeckerei

Geländefahren Kl. M Prfg.Nr: 40 nur

Tore A-E

Geländefahren Kl. A Prfg.Nr: 2; 6 und 10 nur

Tore A-D

CAI 3* **CAI 2***

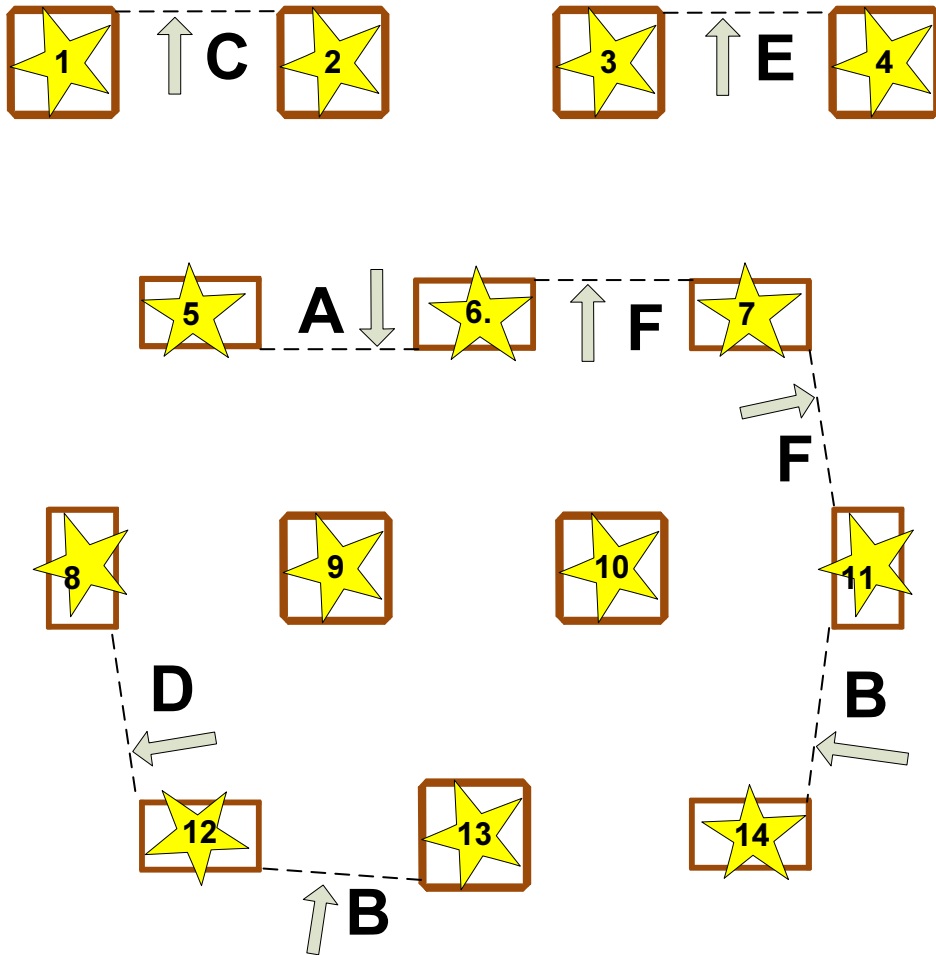

Start / Finish

= 14 Knock Down

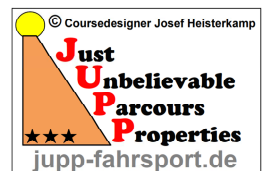



Internationales Fahrturnier
International Driving Event
CAI 3*/CAI 2*
Nationales Fahrturnier
CAN
09.04.-12.04.2026

Hindernis
Obstacle **4**

Powered by:



Märchenwald

CAI 3*
CAI 2*

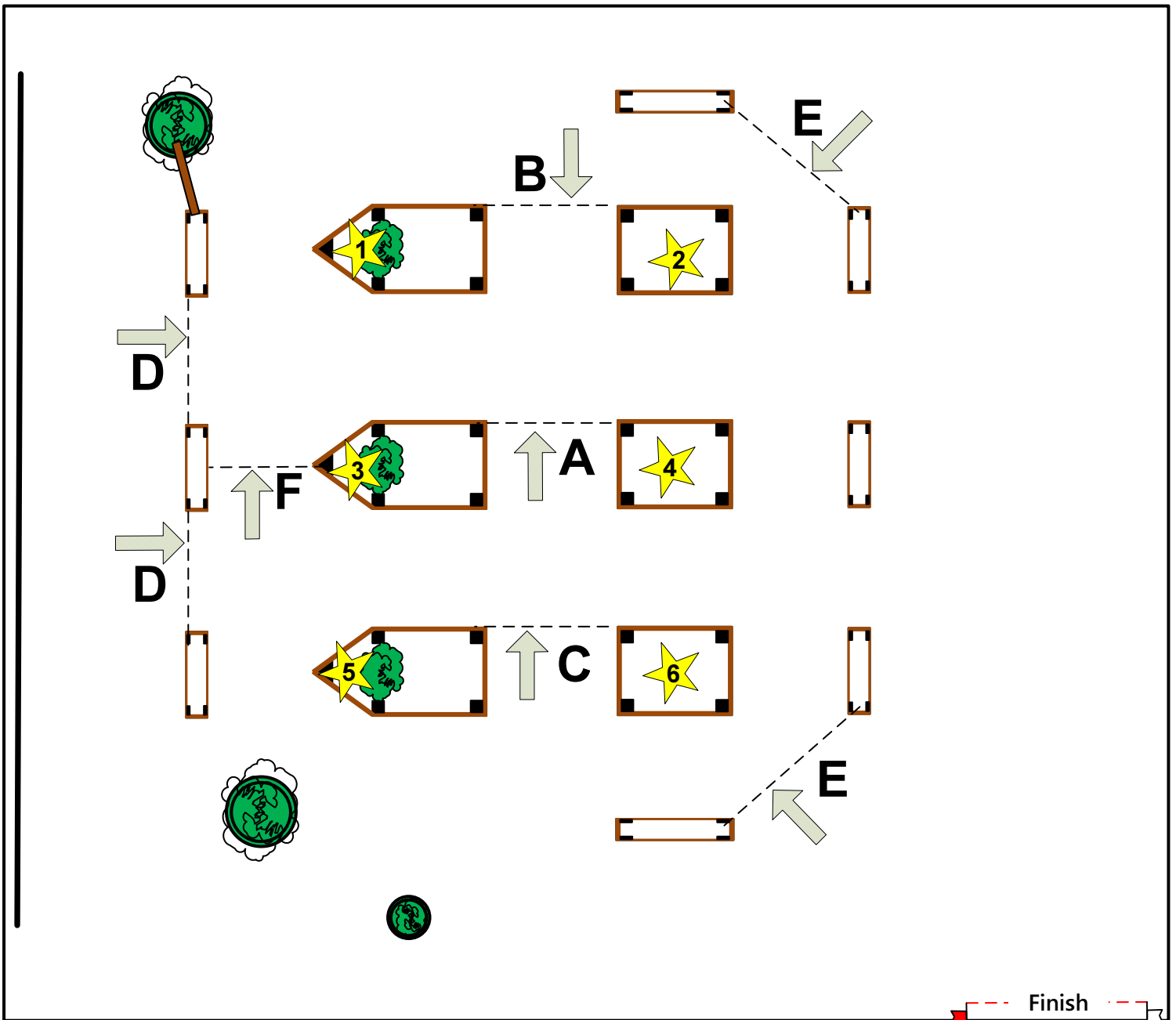



Internationales Fahrturnier
International Driving Event
CAI 3*/CAI 2*
Nationales Fahrturnier
CAN
09.04.-12.04.2026

Hindernis
Obstacle **5**

Powered by:



CAI 3*
CAI 2*

Menzel's
Wassergraben

Geländefahren Kl. M Prfg.Nr: 40 nur

Tore A-E

Geländefahren Kl. A Prfg.Nr: 2; 6 und 10 nur

Tore A-D

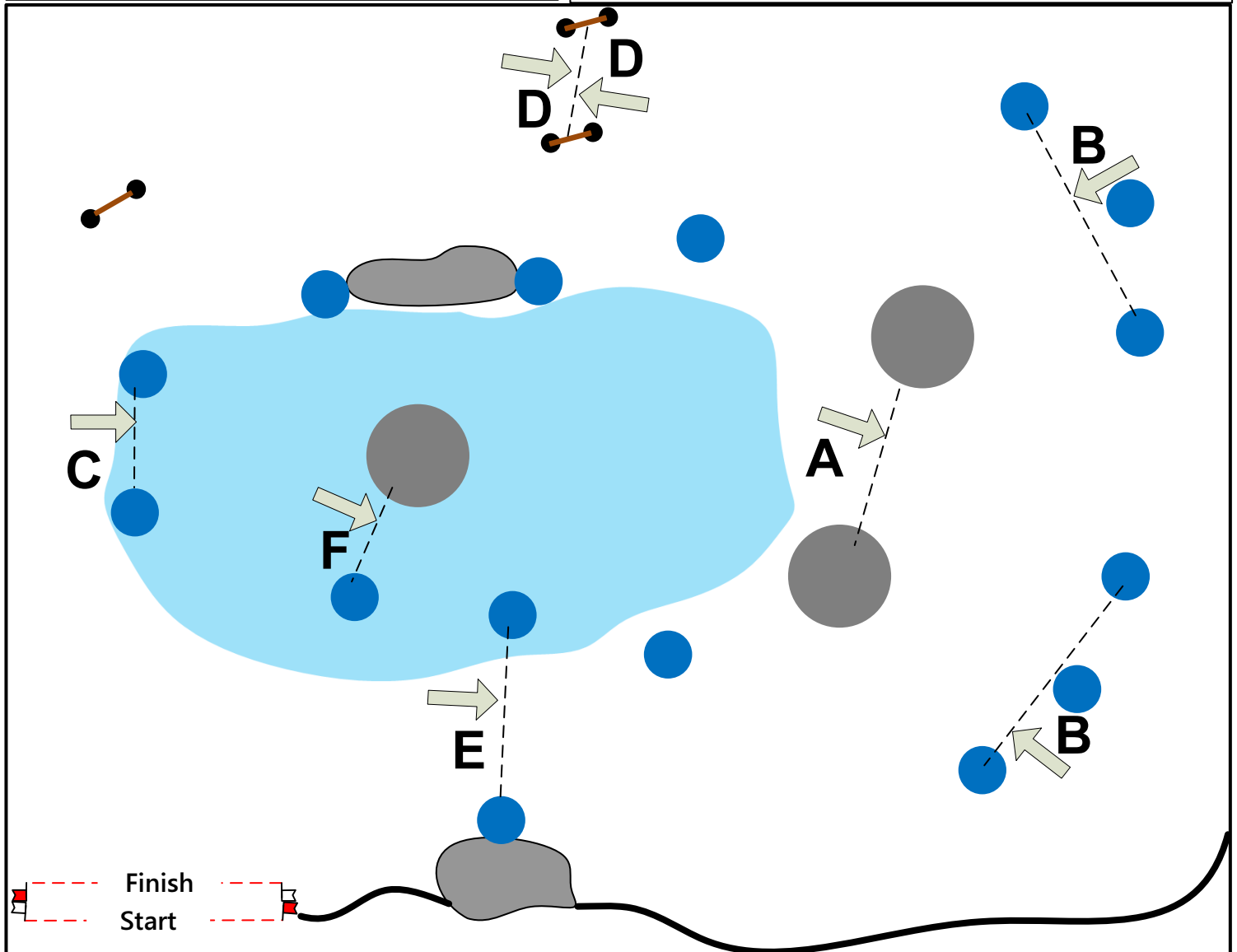



Internationales Fahrturnier
 International Driving Event
 CAI 3*/CAI 2*
 Nationales Fahrturnier
 CAN
 09.04.-12.04.2026

Hindernis
Obstacle **7**

Powered by:



Hüsches Gruppe®
 Die Gutachter

CAI 3*
CAI 2*

Hüsches
PS Schuppen

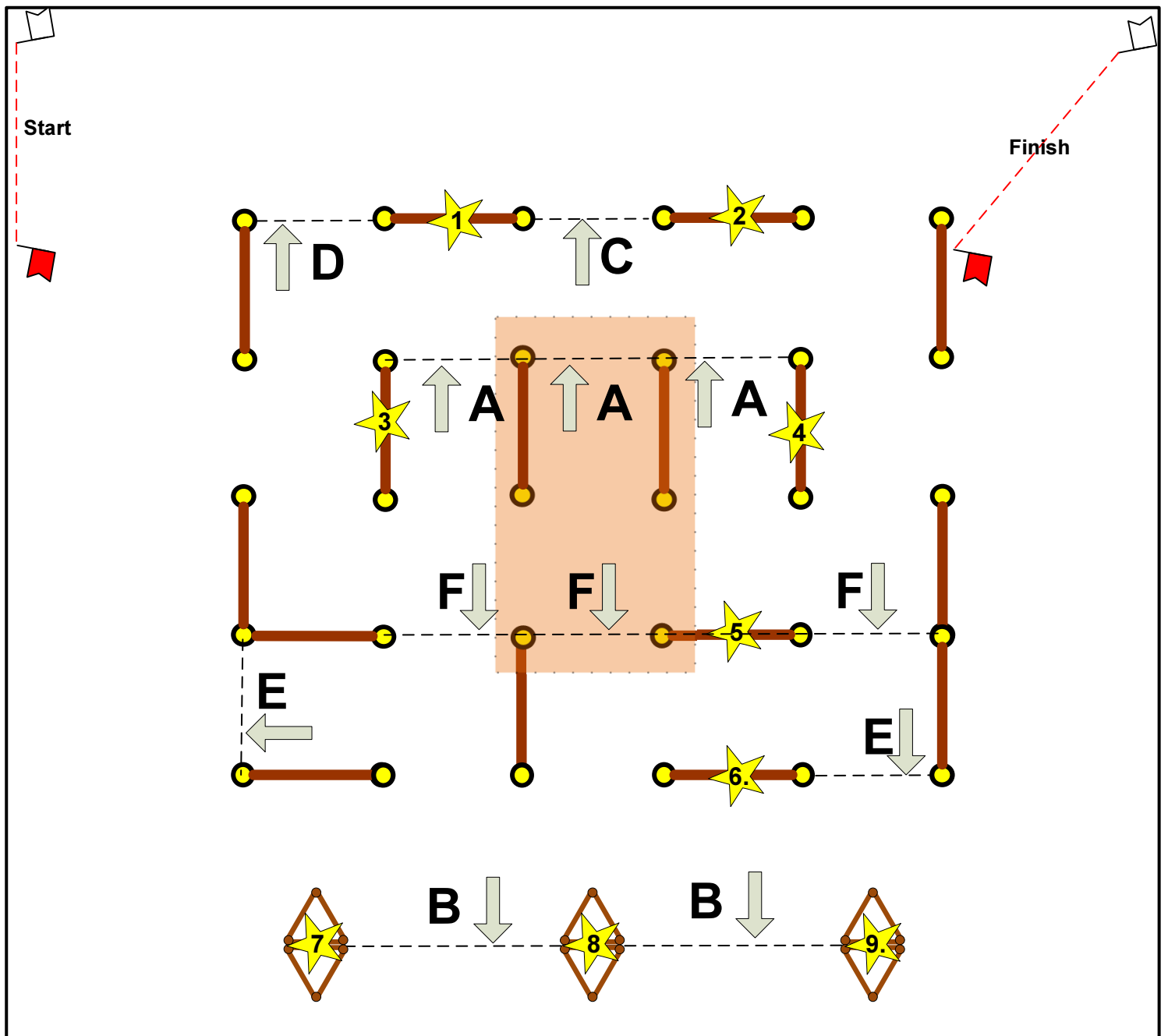

= 9 Knock Down