



**Internationales Fahrturnier
International Driving Event
CAI 3*/CAI 2*
Nationales Fahrturnier
CAN**

20.04.-23.04.2023

**Liebe Teilnehmer/innen,
Herzlich Willkommen zum diesjährigen Fahrturnier
beim
„Fahr - und Reitverein Wettringen“.
Getreu unserem Motto
„Turnier von Fahrern für Fahrer“
wünschen wir Euch viel Erfolg und vor Allem viel
Spaß!**

**Dear participants,
Welcome to this year's driving competition at
„Fahr - und Reitverein Wettringen“.
True to our motto
"Tournament by drivers for drivers"
we wish you success and above all a lot of fun!**

Teilnehmerunterlagen Competitorsmap

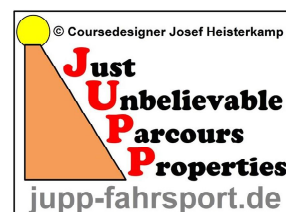



**Internationales Fahrturnier
International Driving Event CAI 3*/CAI 2*
Nationales Fahrturnier CAN
20.04.-23.04.2023**

**Section A for all
classes
Aufwärmstrecke für
alle Klassen**

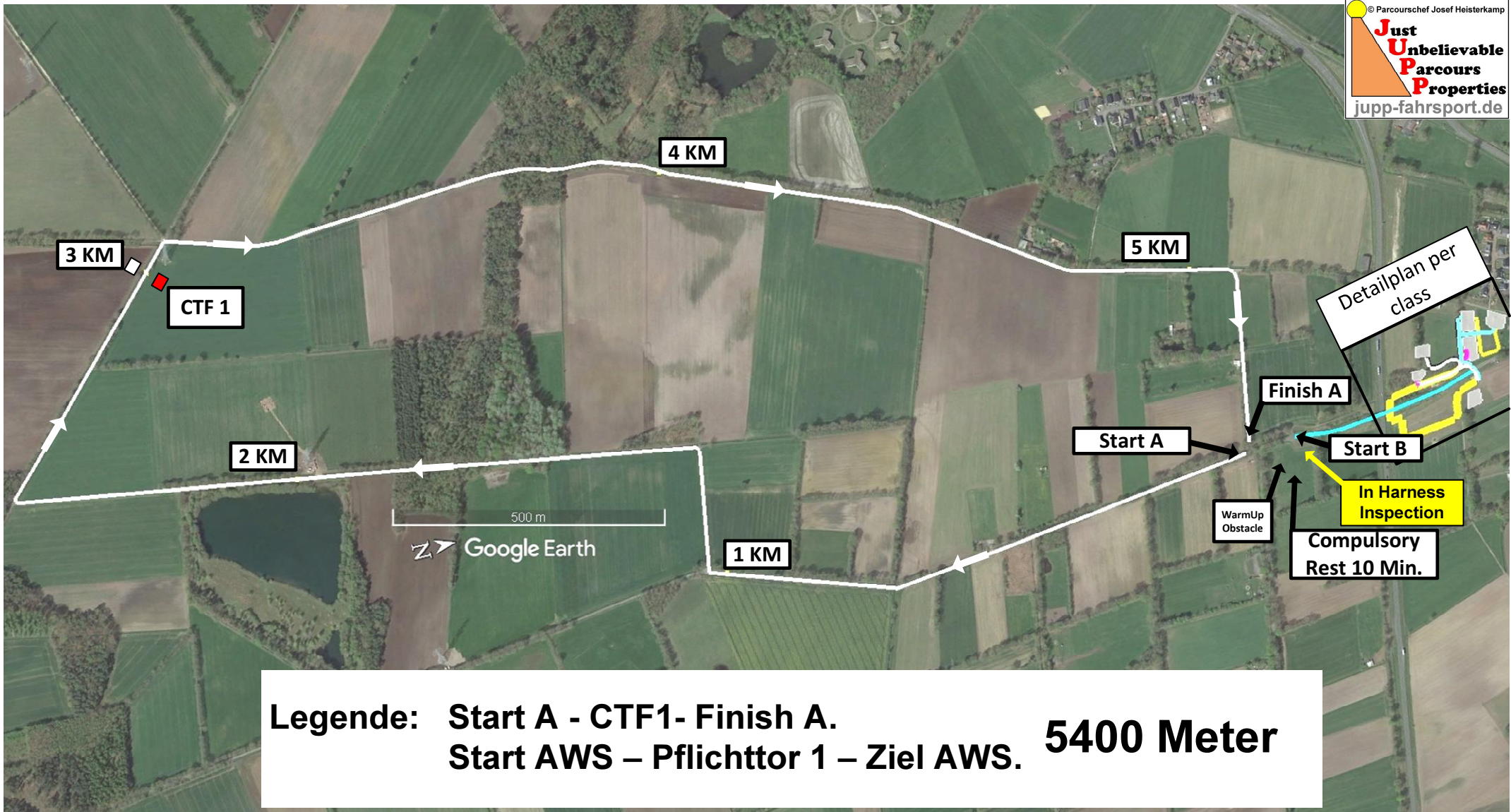



**Internationales Fahrturnier
International Driving Event CAI 3*/CAI 2*
Nationales Fahrturnier CAN**

20.04.-23.04.2023

**Section B 3*
5290 Meter**

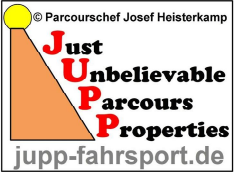
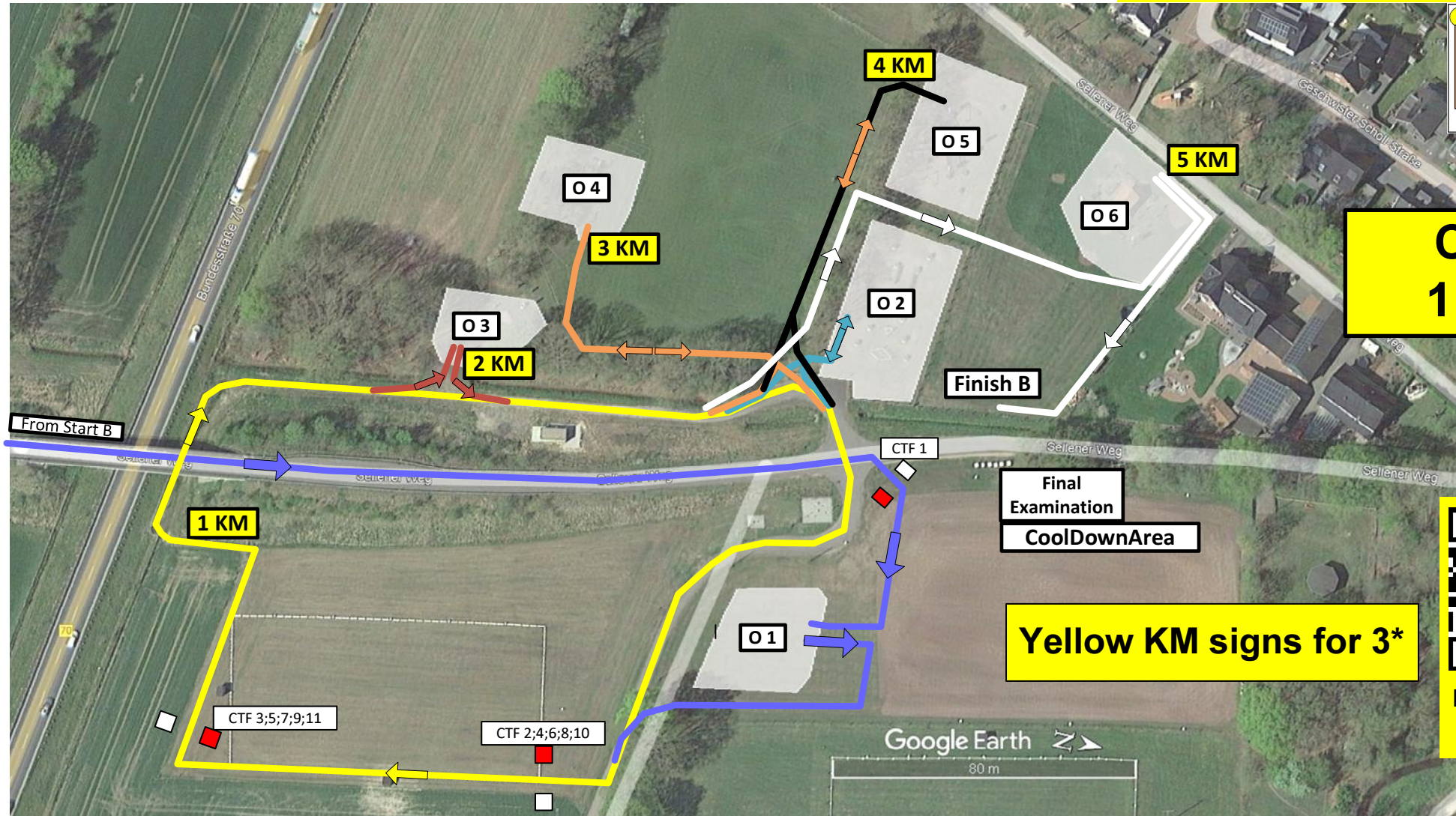

**CTF
1 - 11**

Yellow KM signs for 3*



**Downloadlink
3* Marathon**

Legende: Start B / CTF1 / O1 / CTF2 / CTF3 / 1KM / O2 / CTF4 / CTF5 / O3 / 2KM / CTF6 / CTF7 / O4 / 3KM / CTF8 / CTF9 / O5 / 4KM / CTF10 / CTF11 / O6 / 5KM / Finish B. 5290 Meter



Times Marathon Geländezeiten

CAI 3* H1 HORSES	Length in Meter	Tempo KM/h	Minimum Time h:min:sec	Time allowed h:min:sec	Maximum Time h:min:sec	Compulsory Turning Flags
Section A	5400	13	00:22:55	00:24:55	00:29:54	CTF 1
REST				00:10:00		
Section B	5290	14	00:19:40	00:22:40	00:45:21	CTF 1-11
Cool Down	Area		00:10:00		00:15:00	
CAI 3* P1 PONYS	Länge in Meter	Tempo KM/h	Minimum Time h:min:sec	Time allowed h:min:sec	Maximum Time h:min:sec	Compulsory Turning Flags/ Pflichttore
Section A	5400	12	00:25:00	00:27:00	00:32:24	CTF 1
REST				00:10:00		
Section B	5290	13	00:21:25	00:24:25	00:48:50	CTF 1-11
Cool Down	Area		00:10:00		00:15:00	
CAI 2* H1 HORSES	Länge in Meter	Tempo KM/h	Minimum Time h:min:sec	Time allowed h:min:sec	Maximum Time h:min:sec	Compulsory Turning Flags/ Pflichttore
Section A	5400	12	00:25:00	00:27:00	00:32:24	CTF 1
REST				00:10:00		
Section B	5000	13	00:20:05	00:23:05	00:46:09	CTF 2-11
Cool Down	Area		00:10:00		00:15:00	
CAI 2* P1 PONYS	Länge in Meter	Tempo KM/h	Minimum Time h:min:sec	Time allowed h:min:sec	Maximum Time h:min:sec	Compulsory Turning Flags/ Pflichttore
Section A	5400	11	00:27:27	00:29:27	00:35:21	CTF 1
REST				00:10:00		
Section B	5000	12	00:22:00	00:25:00	00:50:00	CTF 2-11
Cool Down	Area		00:10:00		00:15:00	
Klasse A national PFERDE	Länge in Meter	Tempo KM/h	Minimum Time h:min:sec	Time allowed h:min:sec	Maximum Time h:min:sec	Compulsory Turning Flags/ Pflichttore
Aufwärmstrecke	5400	11,5	00:26:10	00:28:10	00:33:49	CTF 1
Zwangspause				00:10:00		
Hindernisstrecke	3845	12,5	00:15:27	00:18:27	00:36:55	CTF 2-9
Klasse A national PONYS	Länge in Meter	Tempo KM/h	Minimum Time h:min:sec	Time allowed h:min:sec	Maximum Time h:min:sec	Compulsory Turning Flags/ Pflichttore
Aufwärmstrecke	5400	11	00:27:27	00:29:27	00:35:21	CTF 1
Zwangspause				00:10:00		
Hindernisstrecke	3845	12	00:16:14	00:19:14	00:38:27	CTF 2-9



Internationales Fahrturnier
International Driving Event
CAI 3*/CAI 2*
Nationales Fahrturnier
CAN
20.04.-23.04.2023

Hindernis
Obstacle
1

CAI 3* only!

Powered by:

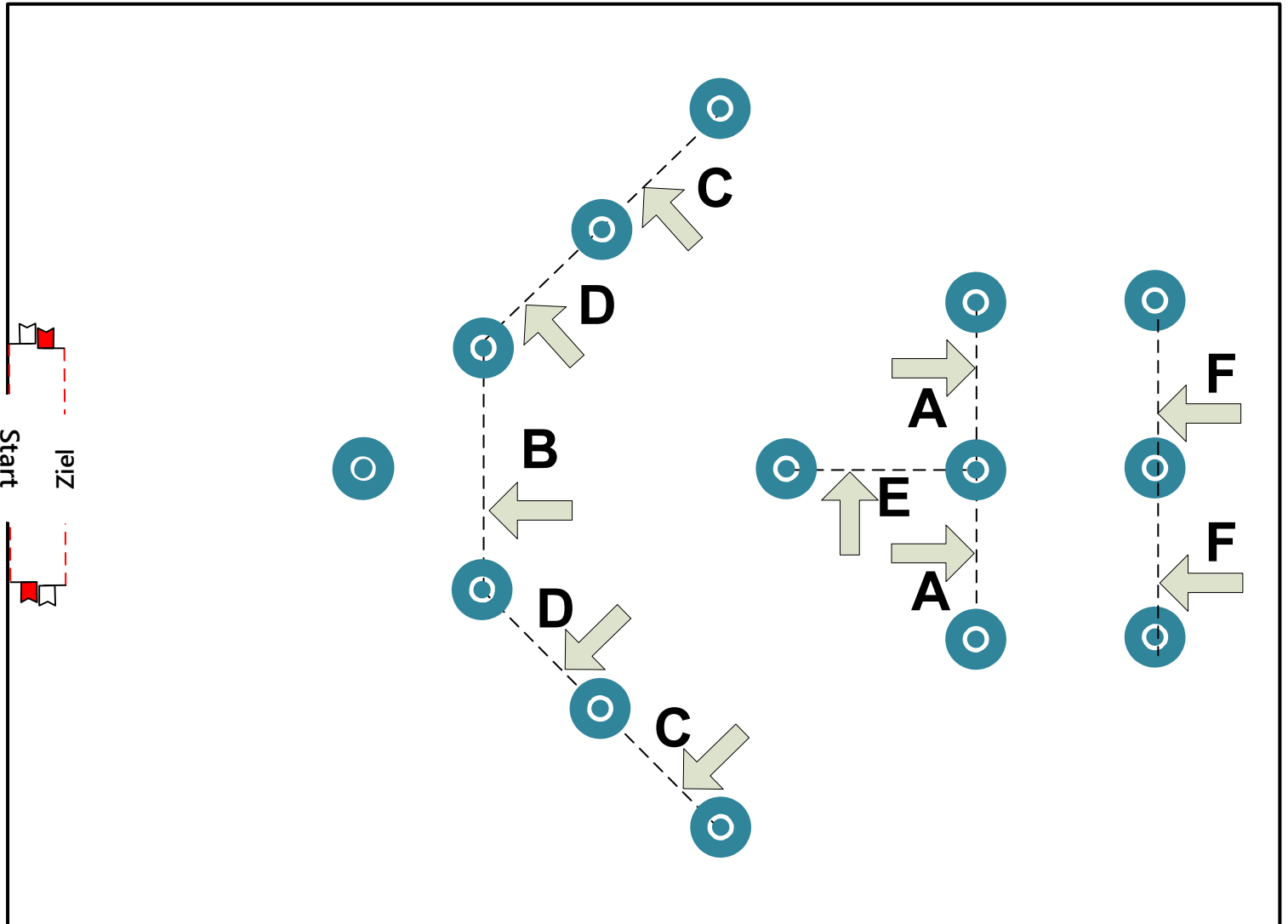



Internationales Fahrturnier
International Driving Event
CAI 3*/CAI 2*
Nationales Fahrturnier
CAN
20.04.-23.04.2023

Hindernis
Obstacle **2**

Powered by:



Geländefahren Kl. A
Prfg.Nr: 19;23;27;31;35 und 36 nur
Tore A-D

Wall

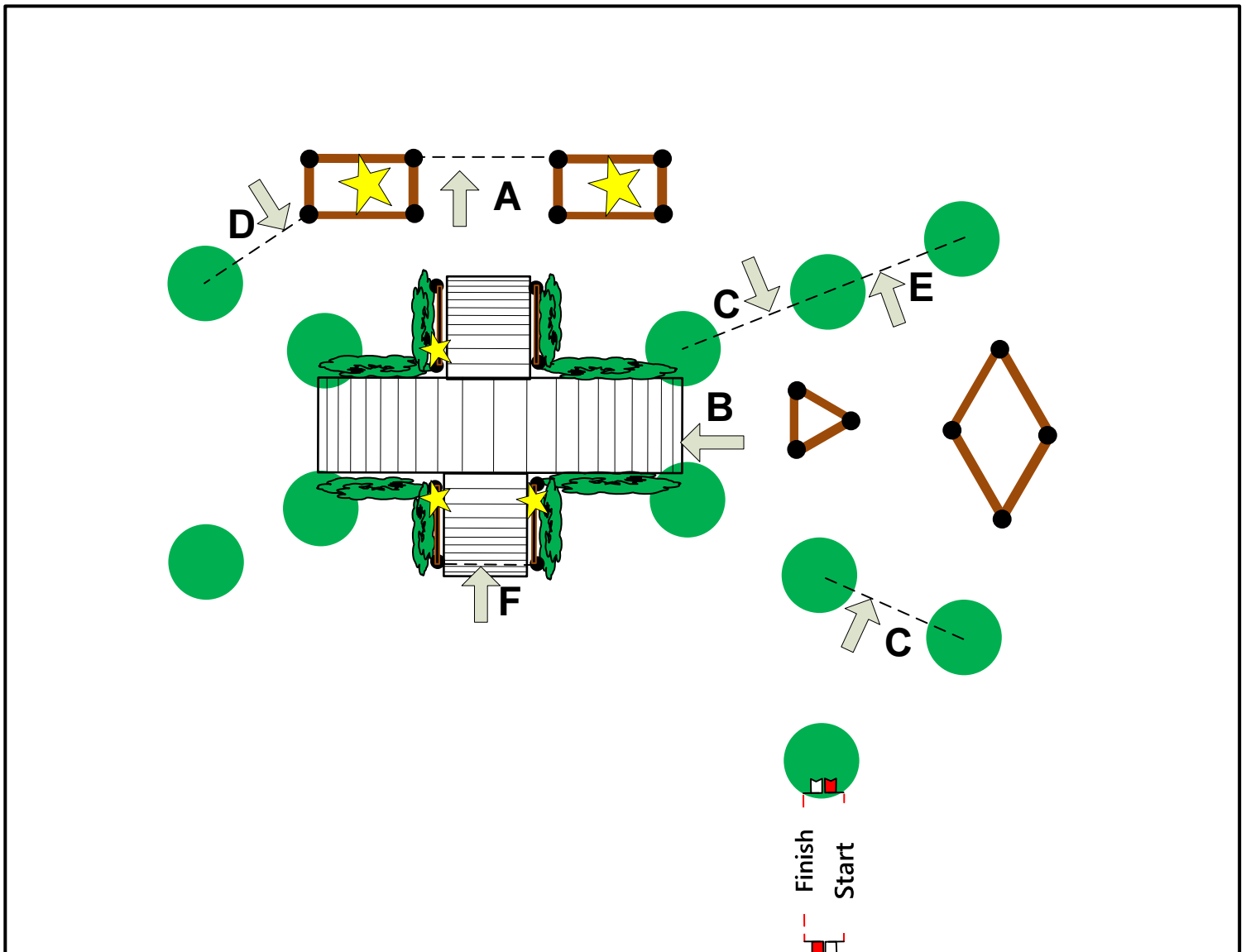

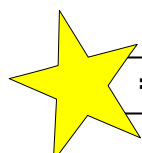
 = 5 Knock Down



Internationales Fahrturnier
International Driving Event
CAI 3*/CAI 2*
Nationales Fahrturnier
CAN
20.04.-23.04.2023

Hindernis **3**
Obstacle

Powered by:



Menzel's Wassergraben

Geländefahren Kl. A

Prfg.Nr: 19;23;27;31;35 und 36 nur

Tore A-D

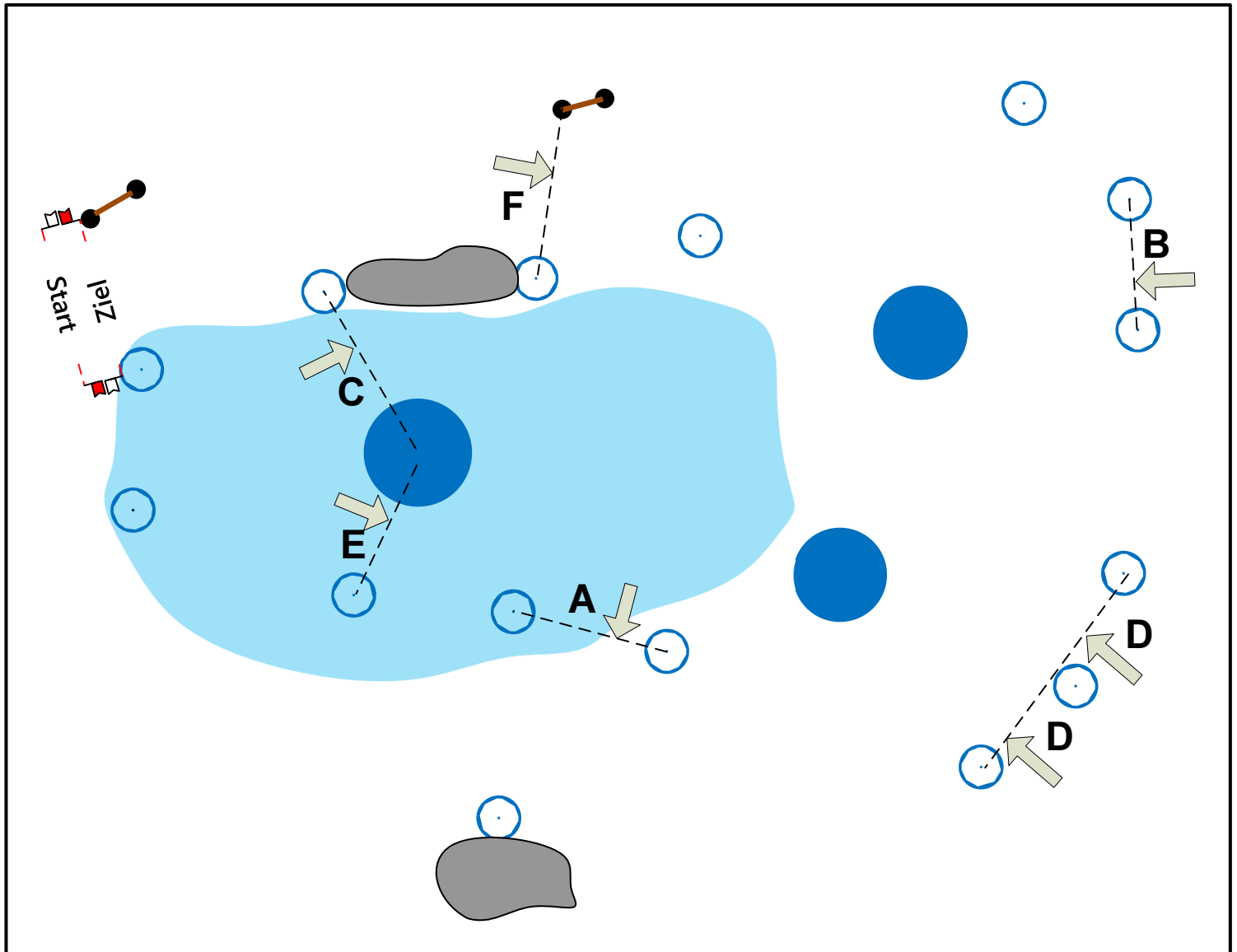



Internationales Fahrturnier
International Driving Event
CAI 3*/CAI 2*
Nationales Fahrturnier
CAN
20.04.-23.04.2023

Hindernis
Obstacle
4

Powered by:



Märchenwald

CAI 2* only Gate A-E

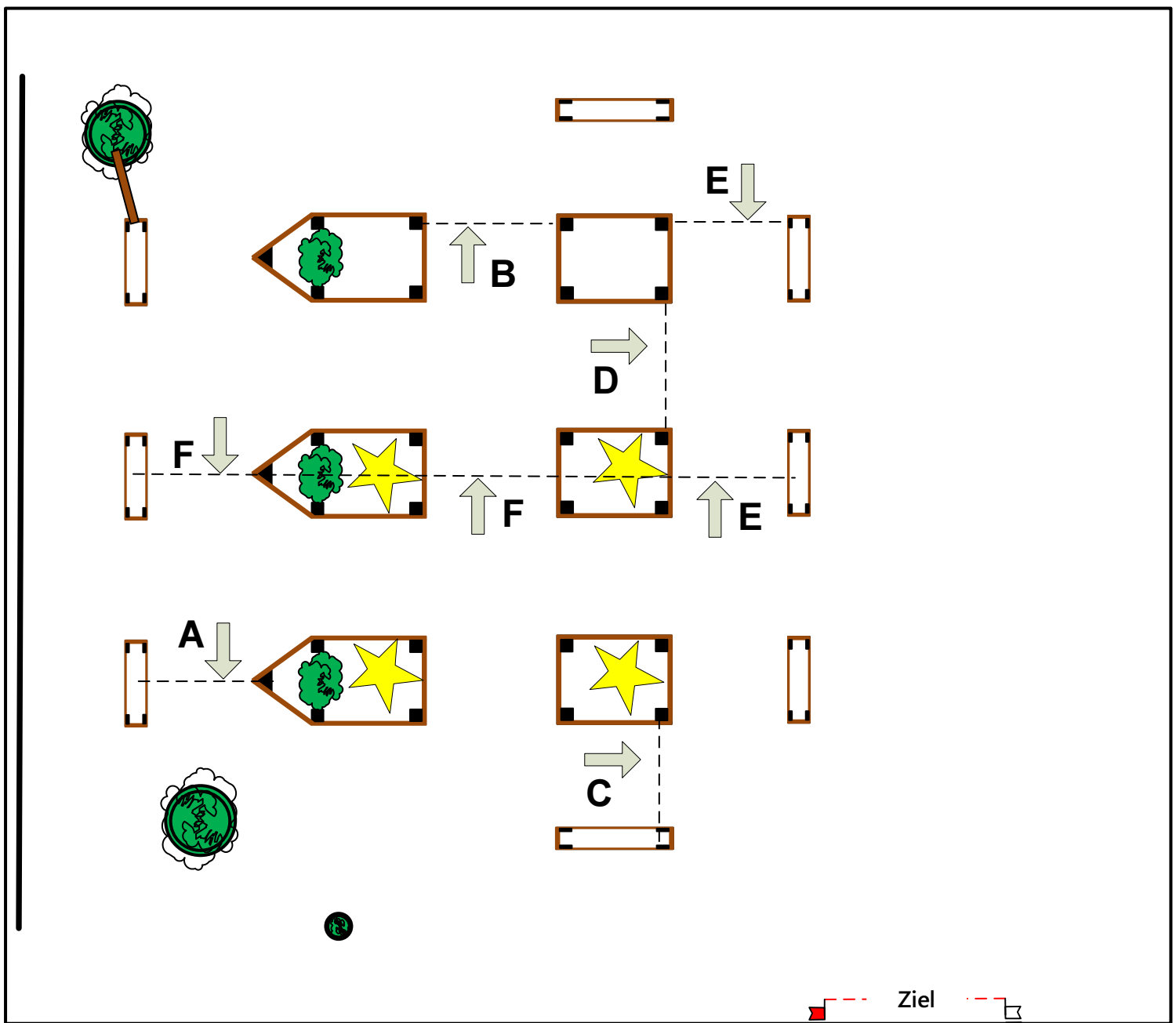

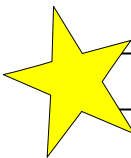
 = 4 Knock Down



Internationales Fahrturnier
International Driving Event
CAI 3*/CAI 2*
Nationales Fahrturnier
CAN
20.04.-23.04.2023

Hindernis
Obstacle **5**

Powered by:



Elektro Brinner Brücke

Geländefahren Kl. A
Prfg.Nr: 19;23;27;31;35 und 36 nur
Tore A-D

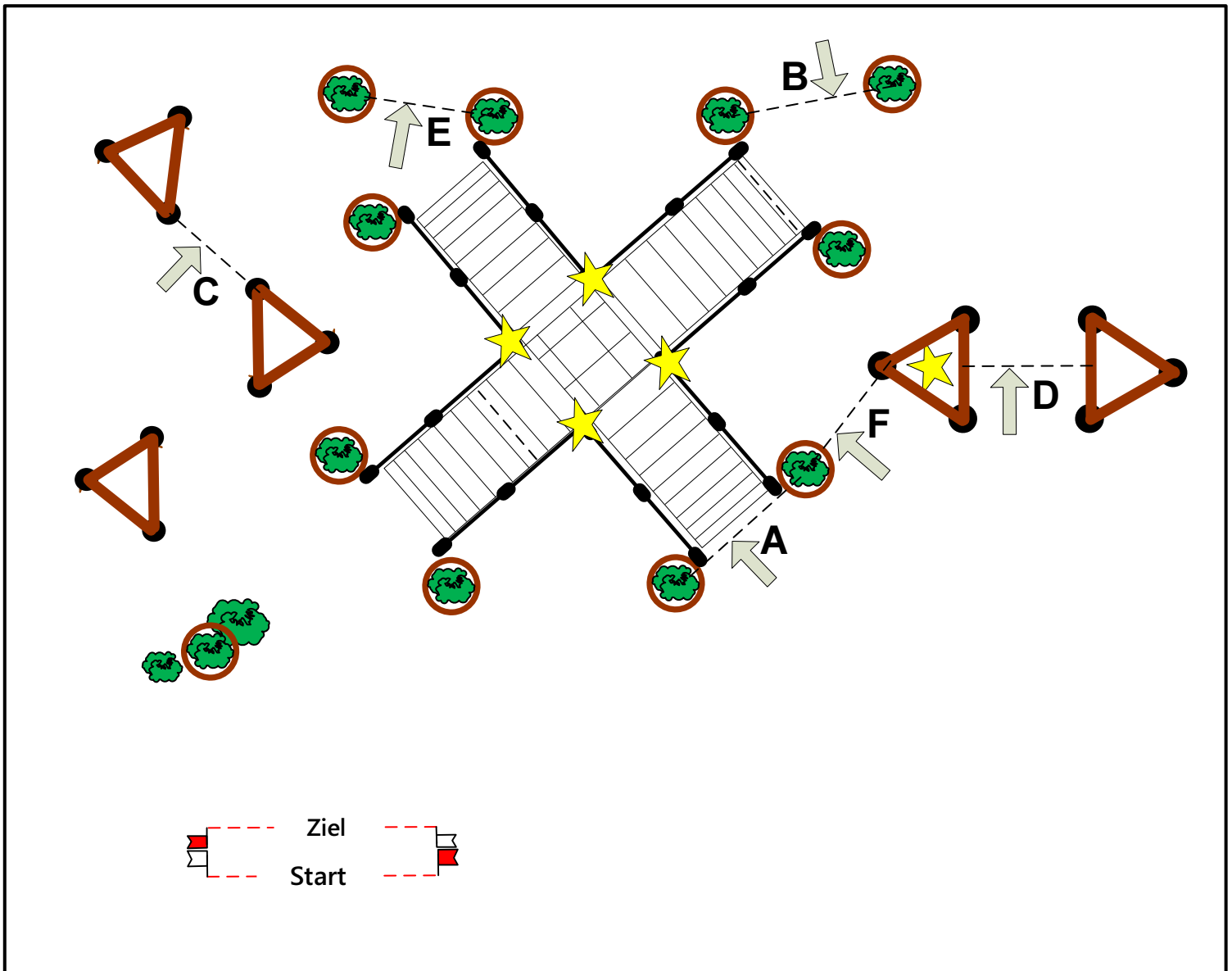

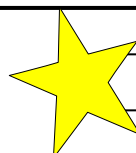
 = 5 Knock Down



Internationales Fahrturnier
International Driving Event
CAI 3*/CAI 2*
Nationales Fahrturnier
CAN
20.04.-23.04.2023

Hindernis
Obstacle **6**

Powered by:



Hüsches
PS Schuppen

Geländefahren Kl. A
Prfg.Nr: 19;23;27;31;35 und 36 nur

Tore A-D

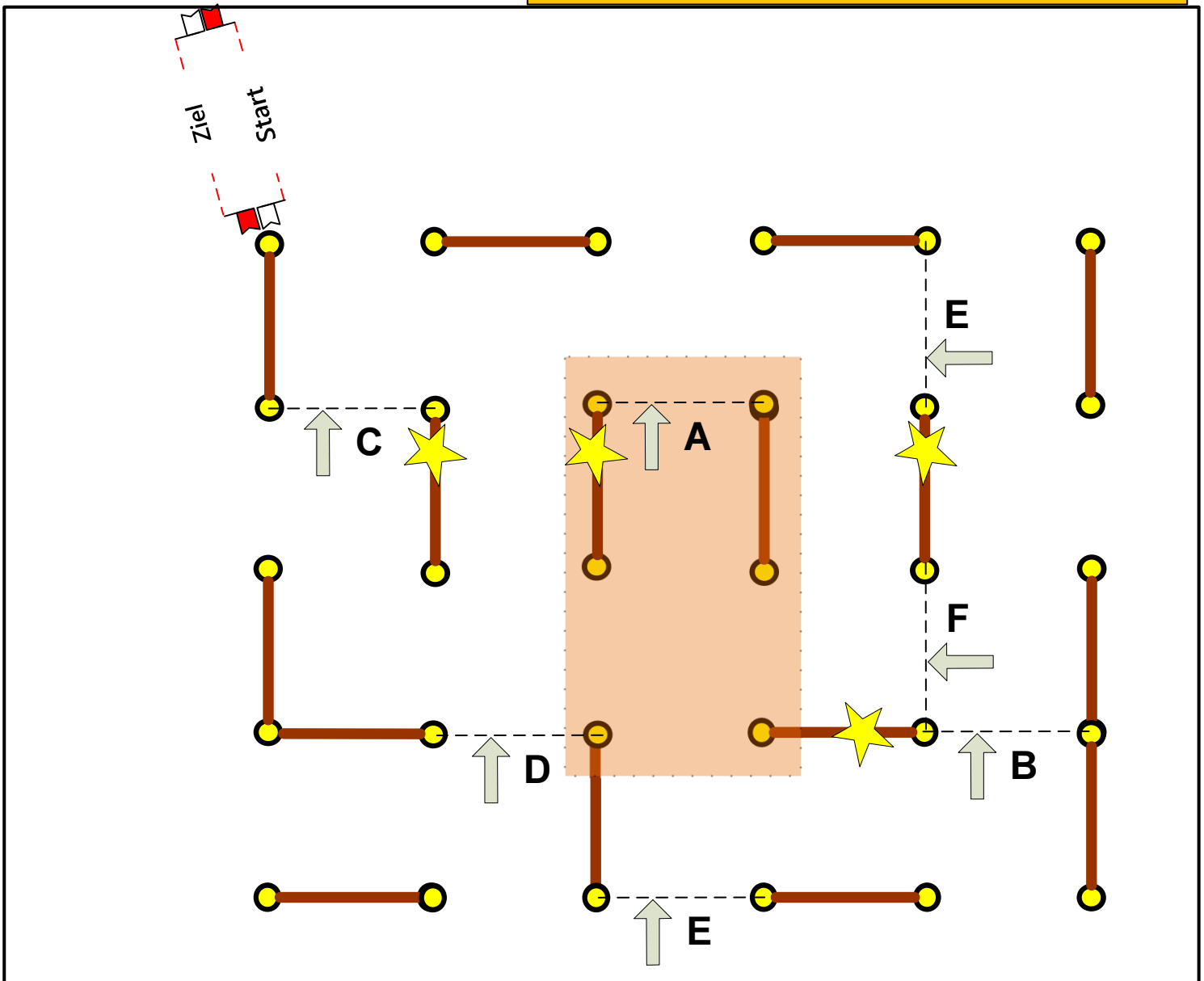

 = 4 Knock Down