

CAI 2*/3*

Bühl GER 2023



HERZLICH WILLKOMMEN BEIM

REIT- UND FAHRVEREIN ST. LEONHARD E.V. - BÜHL



Marathon Info

Section A

Distance: 4400m

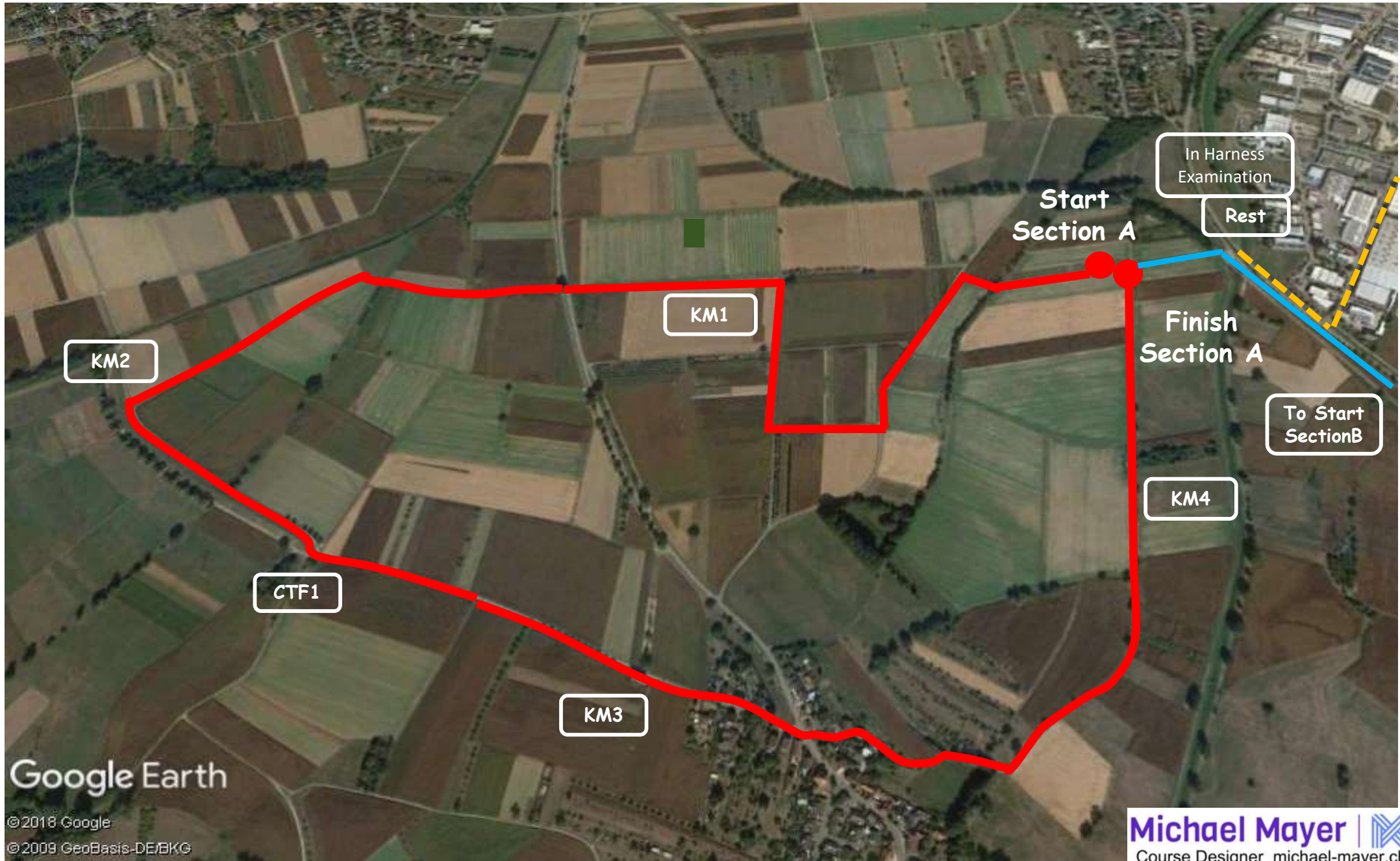



CAI*** Bühl
07. - 11.06.23

Section B

CAI 3*

Distance: 7480m

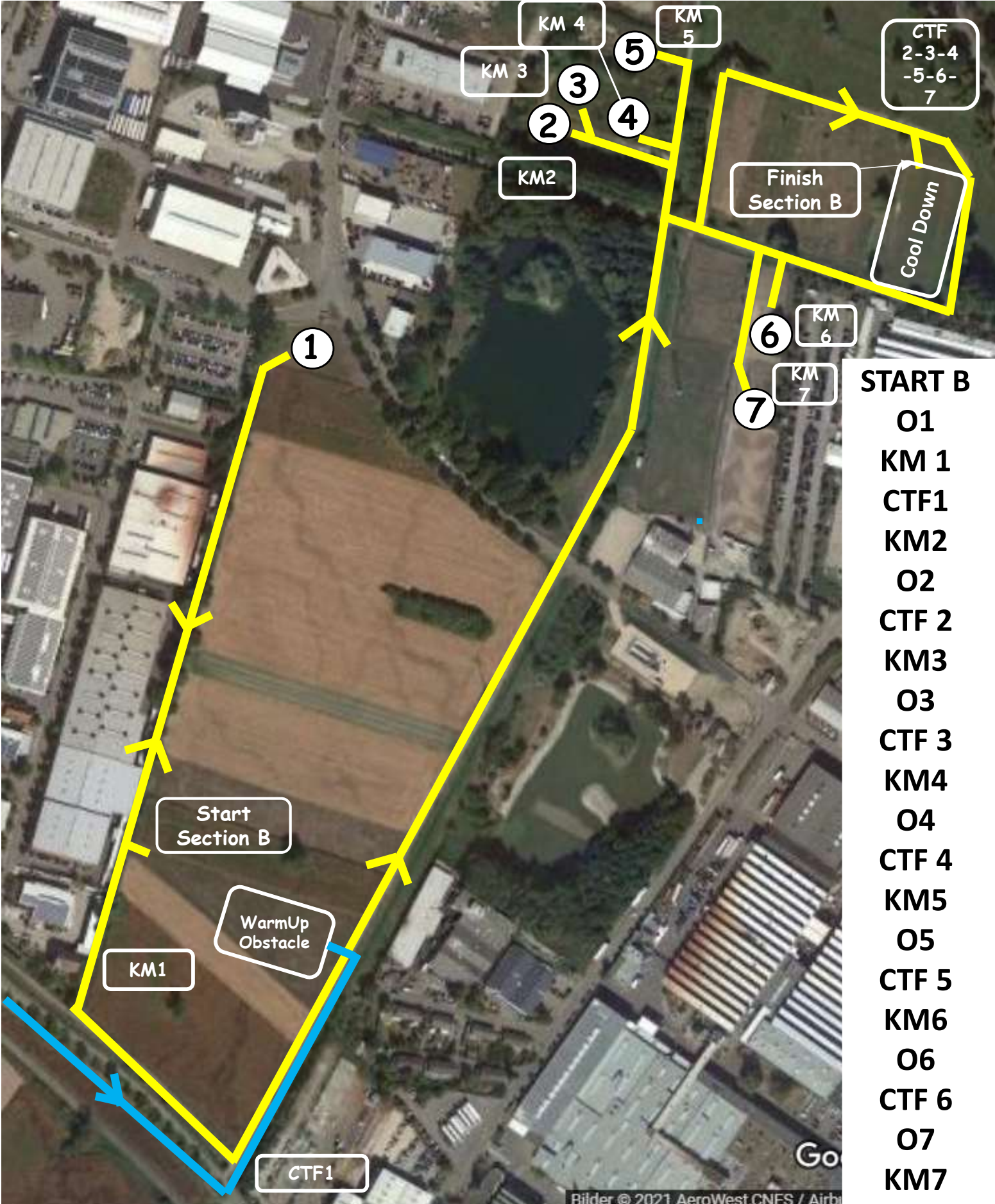

- START B**
- O1
 - KM 1
 - CTF1
 - KM2
 - O2
 - CTF 2
 - KM3
 - O3
 - CTF 3
 - KM4
 - O4
 - CTF 4
 - KM5
 - O5
 - CTF 5
 - KM6
 - O6
 - CTF 6
 - O7
 - KM7
 - CTF7
 - FINISH B**

Bilder © 2021 AeroWest, CNES / Airbus

Section B

CAI 2* / CAIJ 2*

Distance: 7480m

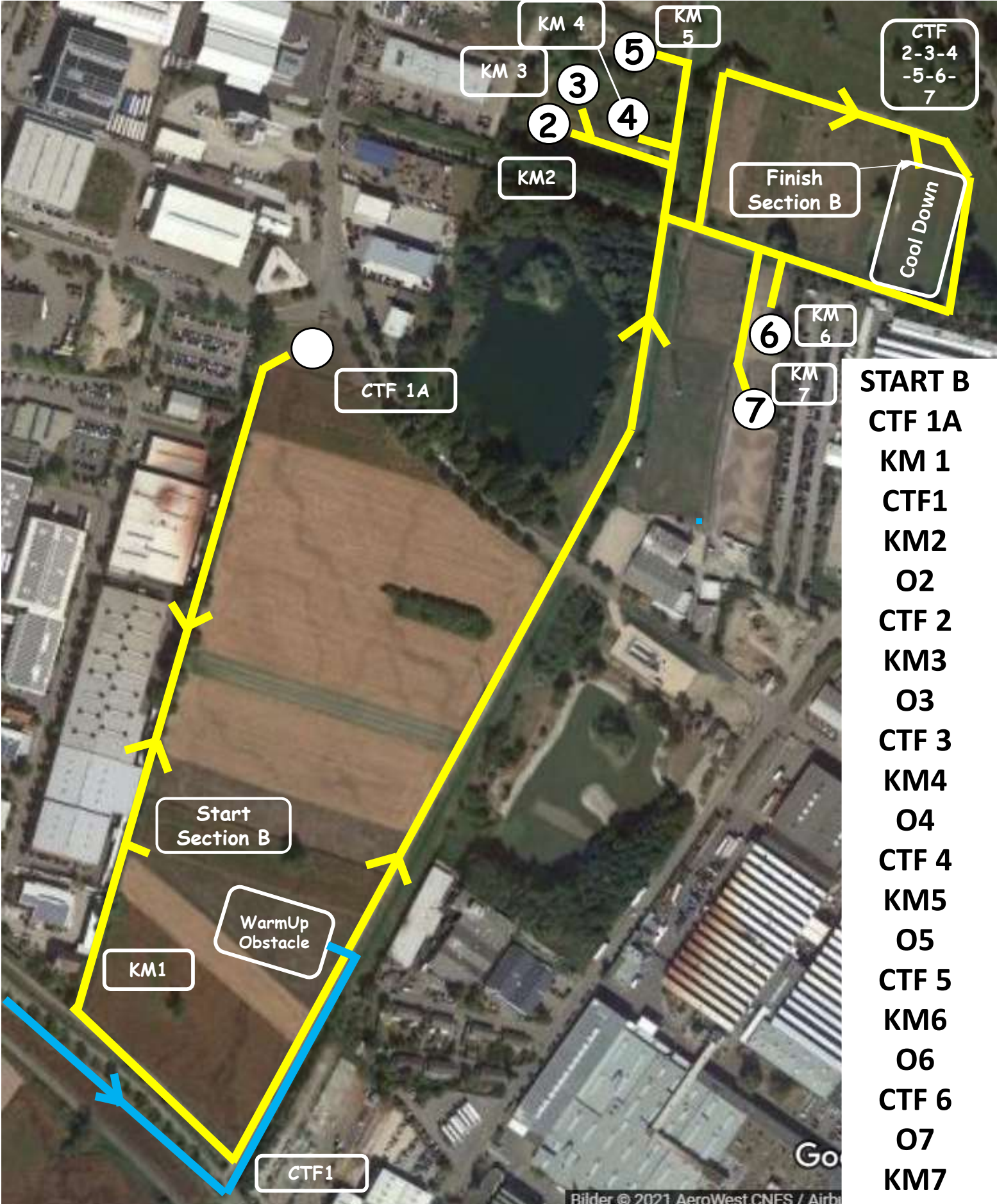

- START B
- CTF 1A
- KM 1
- CTF1
- KM2
- O2
- CTF 2
- KM3
- O3
- CTF 3
- KM4
- O4
- CTF 4
- KM5
- O5
- CTF 5
- KM6
- O6
- CTF 6
- O7
- KM7
- CTF7
- FINISH B



CAI*** Bühl
07. - 11.06.23

Section B

CAICh 2*

Distance: 6530m

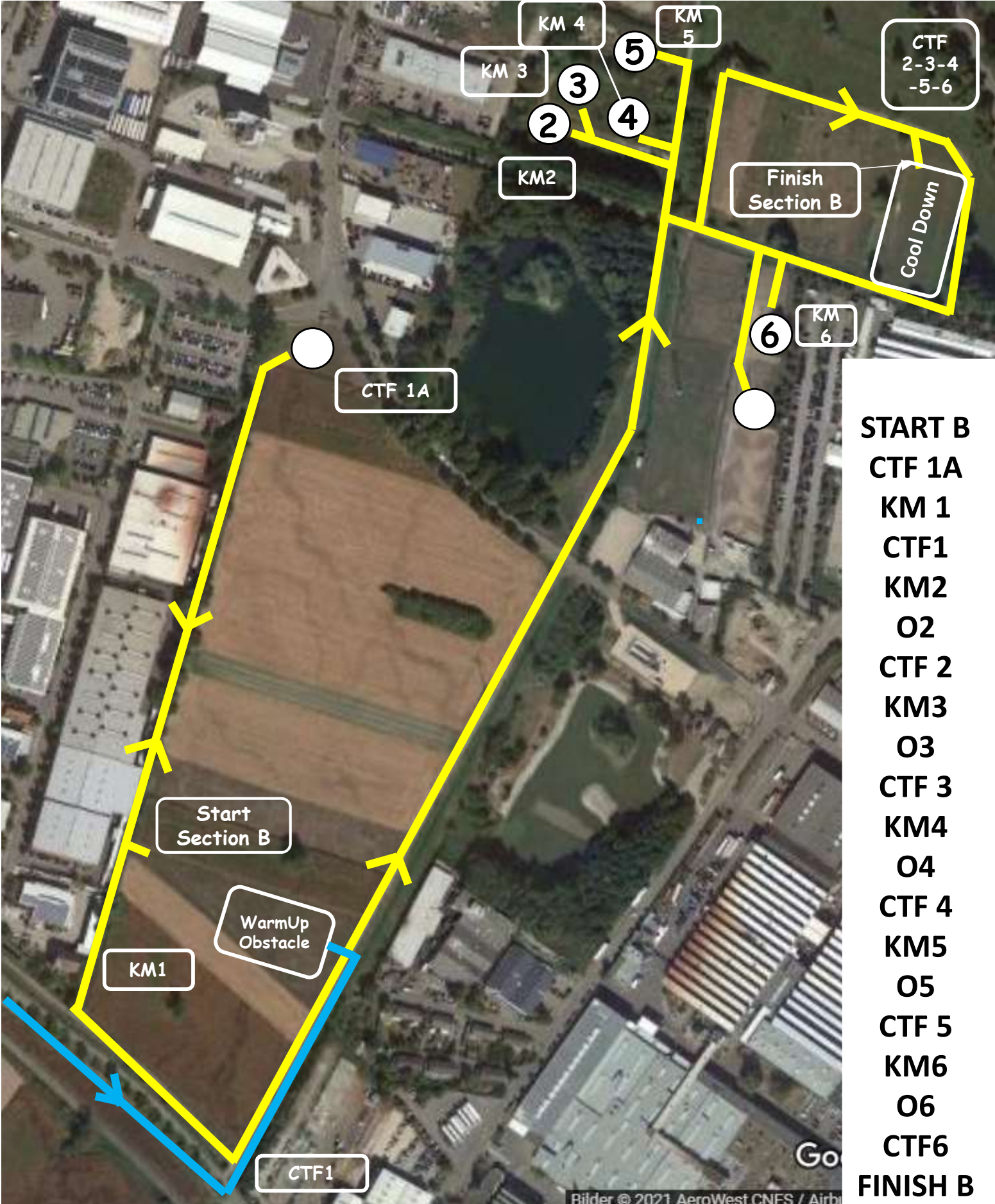

- START B
- CTF 1A
- KM 1
- CTF1
- KM2
- O2
- CTF 2
- KM3
- O3
- CTF 3
- KM4
- O4
- CTF 4
- KM5
- O5
- CTF 5
- KM6
- O6
- CTF6
- FINISH B

Bilder © 2021 AeroWest, CNES / Airbus



**CAI 3* Bühl GER
Marathon
10.06.2023**

Michael Mayer | 
Course Designer michael-mayer.ch

Section Times

Competition: CAI 3* H1-H2-P1-P2

HORSES

Section	Distance	Pace	Speed	MT	TA		CTF
In Harness Examination							
A	4400 m	free	13 km/h	18 min 18 sec	20 min 18 sec		1
Halt				10 min			
Warm Up Obstacle				2 min			
B O 1-7	7480 m	free → after H7 walk or trot	14 km/h	29 min 03 sec	32 min 03 sec		1 - 7
CoolDown In Harness Examination				10 min	15 min		

PONYS

Section	Distance	Pace	Speed	MT	TA		CTF
In Harness Examination							
A	4400 m	free	12 km/h	20 min 00 sec	22 min 00 sec		1
Halt				10 min			
Warm Up Obstacle				2 min			
B O 1-7	7480 m	free → after H7 walk or trot	13 km/h	31 min 31 sec	34 min 31 sec		1 - 7
CoolDown In Harness Examination				10 min	15 min		

TA = Time Allowed / MT = Minimum Time / CTF = Compulsory Turning Flags



CAI 2* CAIJ 2* Bühl GER
Marathon
10.06.2023

Michael Mayer | 
Course Designer michael-mayer.ch

Section Times

Competition: CAI 2* H1-H2-P1-P2 CAIJ 2* P1

HORSES

Section	Distance	Pace	Speed	MT	TA		CTF
In Harness Examination							
A	4400 m	free	13 km/h	18 min 18 sec	20 min 18 sec		1
Halt				10 min			
Warm Up Obstacle				2 min			
B O 2-7	7480 m	free → after H7 walk or trot	14 km/h	29 min 03 sec	32 min 03 sec		1A - 7
CoolDown In Harness Examination				10 min	15 min		

PONYS

Section	Distance	Pace	Speed	MT	TA		CTF
In Harness Examination							
A	4400 m	free	12 km/h	20 min 00 sec	22 min 00 sec		1
Halt				10 min			
Warm Up Obstacle				2 min			
B O 2-7	7480 m	free → after H7 walk or trot	13 km/h	31 min 31 sec	34 min 31 sec		1A - 7
CoolDown In Harness Examination				10 min	15 min		

TA = Time Allowed / MT = Minimum Time / CTF = Compulsory Turning Flags



**CAICh 2* Bühl GER
Marathon
10.06.2023**

Michael Mayer | 
Course Designer michael-mayer.ch

Section Times

Competition: CAICh 2* P1

PONYS

Section	Distance	Pace	Speed	MT	TA		CTF
In Harness Examination							
A	4400 m	free	12 km/h	20 min 00 sec	22 min 00 sec		1
Halt				10 min			
Warm Up Obstacle				2 min			
B O 2-6	6530 m	free → after H7 walk or trot	13 km/h	27 min 08 sec	30 min 08 sec		1A - 6
CoolDown							
In Harness Examination				10 min		15 min	

TA = Time Allowed / MT = Minimum Time / CTF = Compulsory Turning Flags

Obstacle 1: Anonymous Bridge

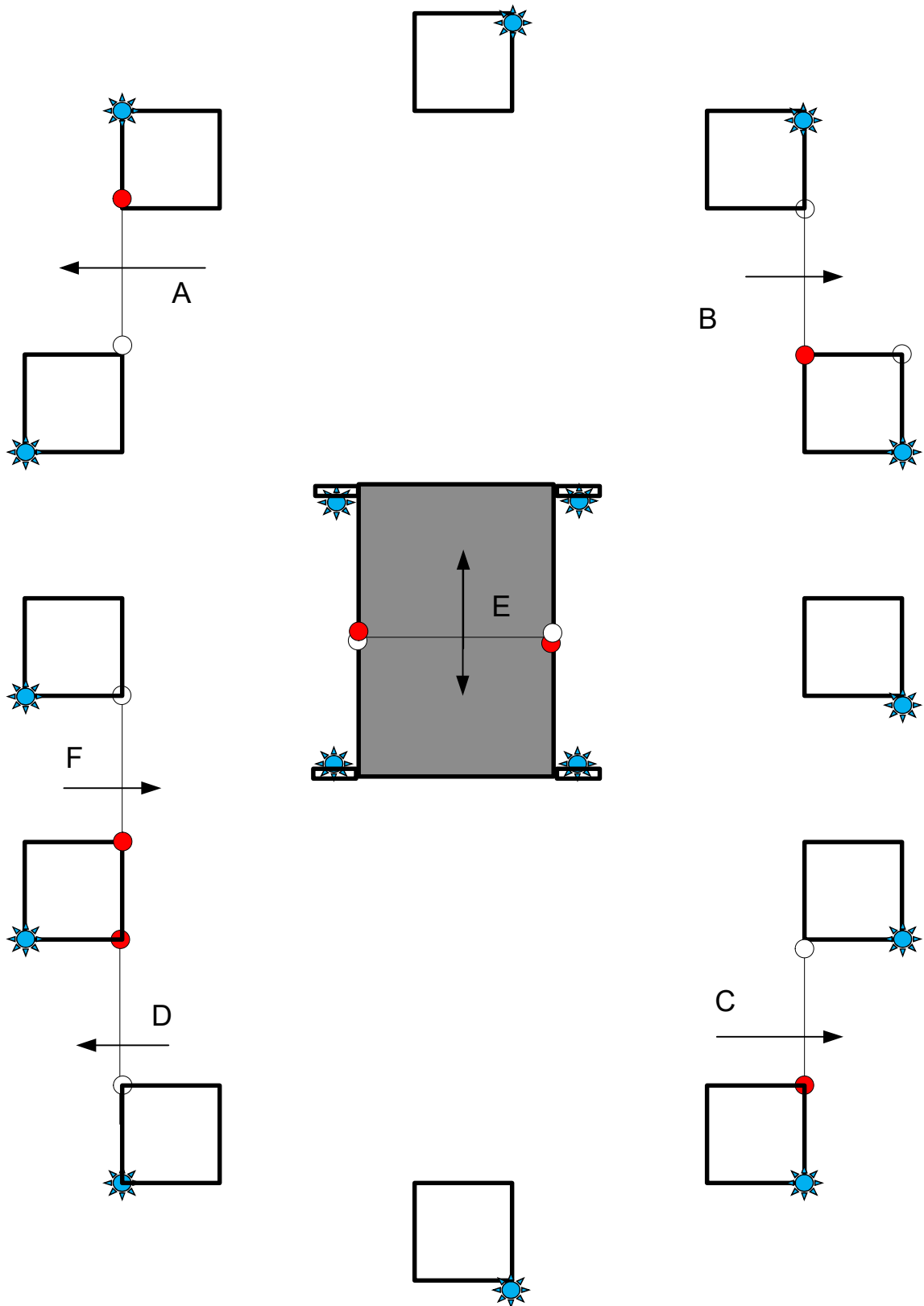

☀ 16 Knock Downs

Michael Mayer | 
 Course Designer michael-mayer.ch
 CD-Ass.: U.Bernhard

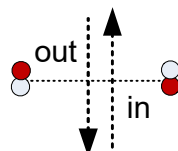

Obstacle 2: Sägewerk Stösser Bühl

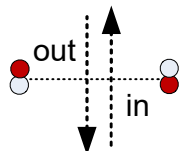
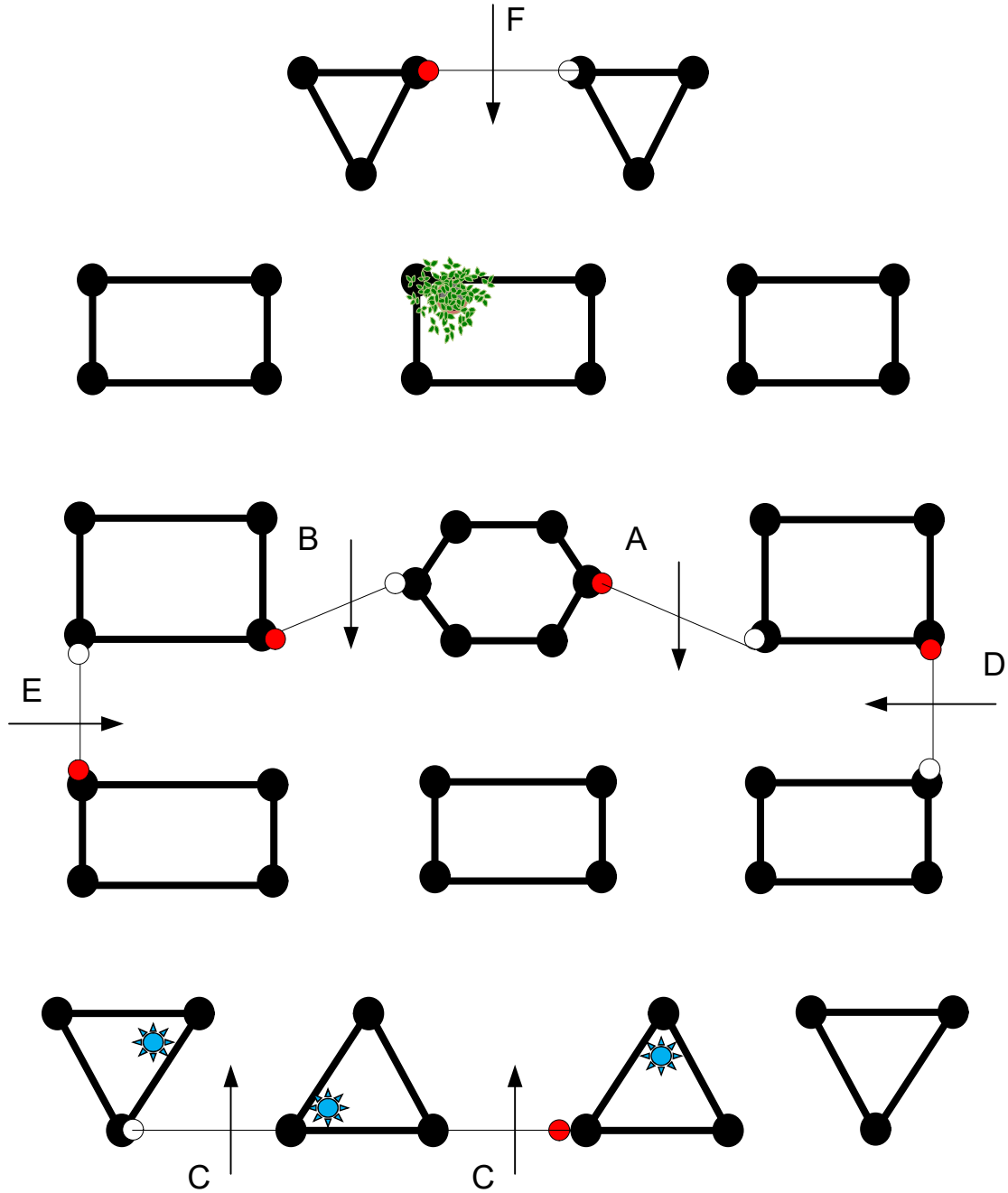

Children CAICh: A-D

 3 Knock Downs

Obstacle 3: Sicon Gescher

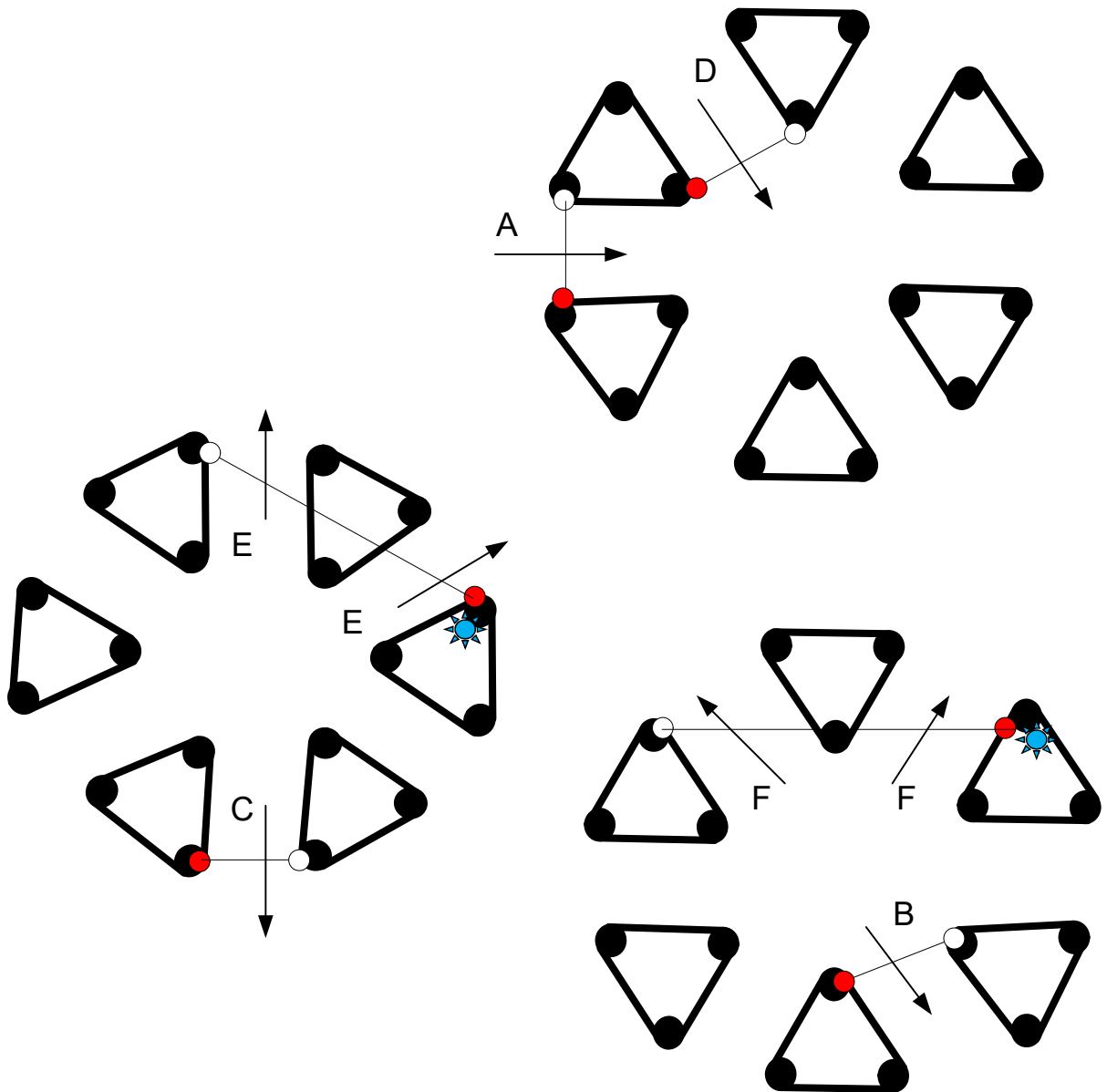

Children CAICh: A-D

 2 Knock Downs

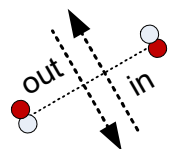

Michael Mayer | 
Course Designer michael-mayer.ch
CD-Ass.: U.Bernhard

Obstacle 4: Boehringer Ingelheim Vetmedica

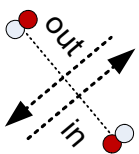
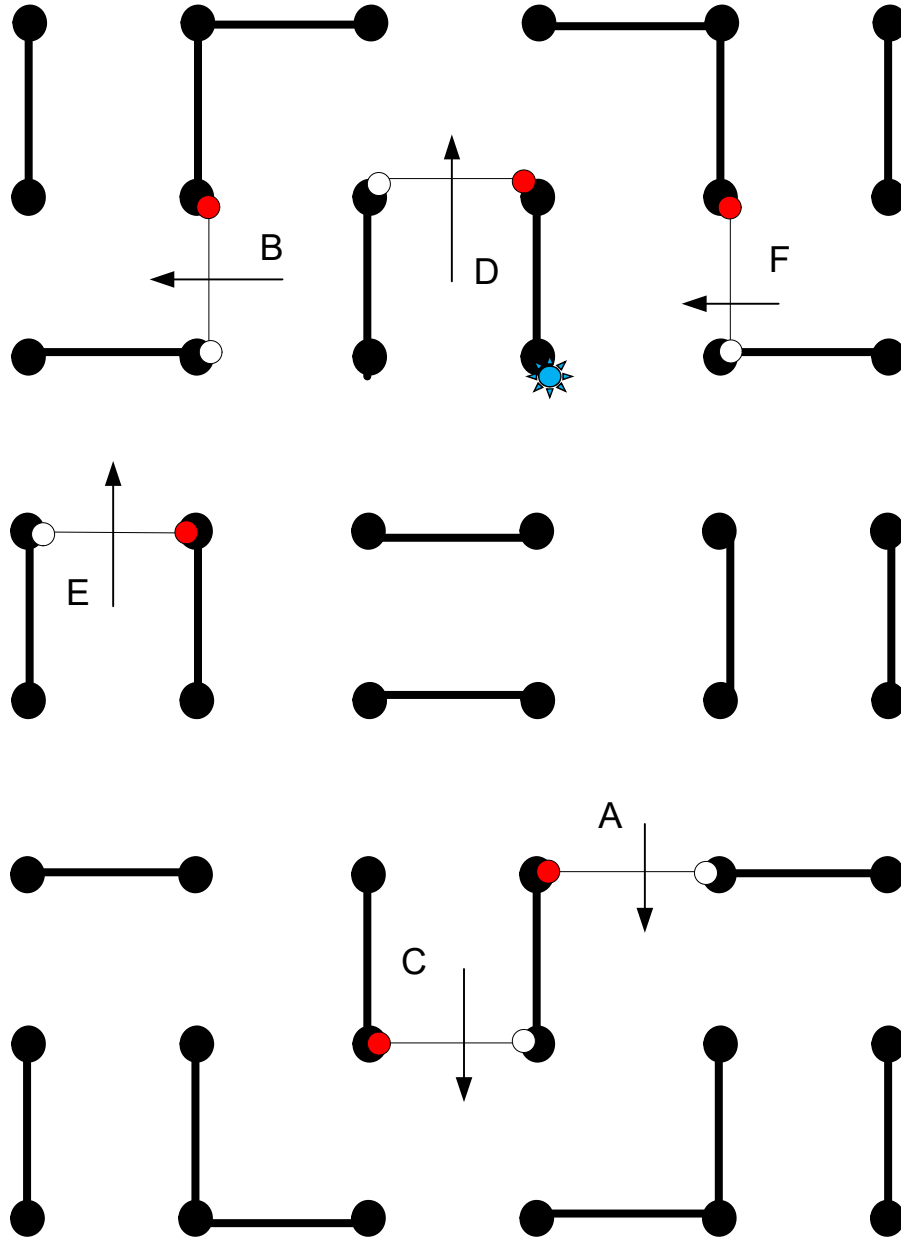

Children CAICh: A-D

 1 Knock Downs

Michael Mayer | 
Course Designer michael-mayer.ch
CD-Ass.: U.Bernhard

Obstacle 5: Umweltpartner Vogel AG

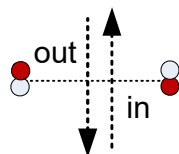
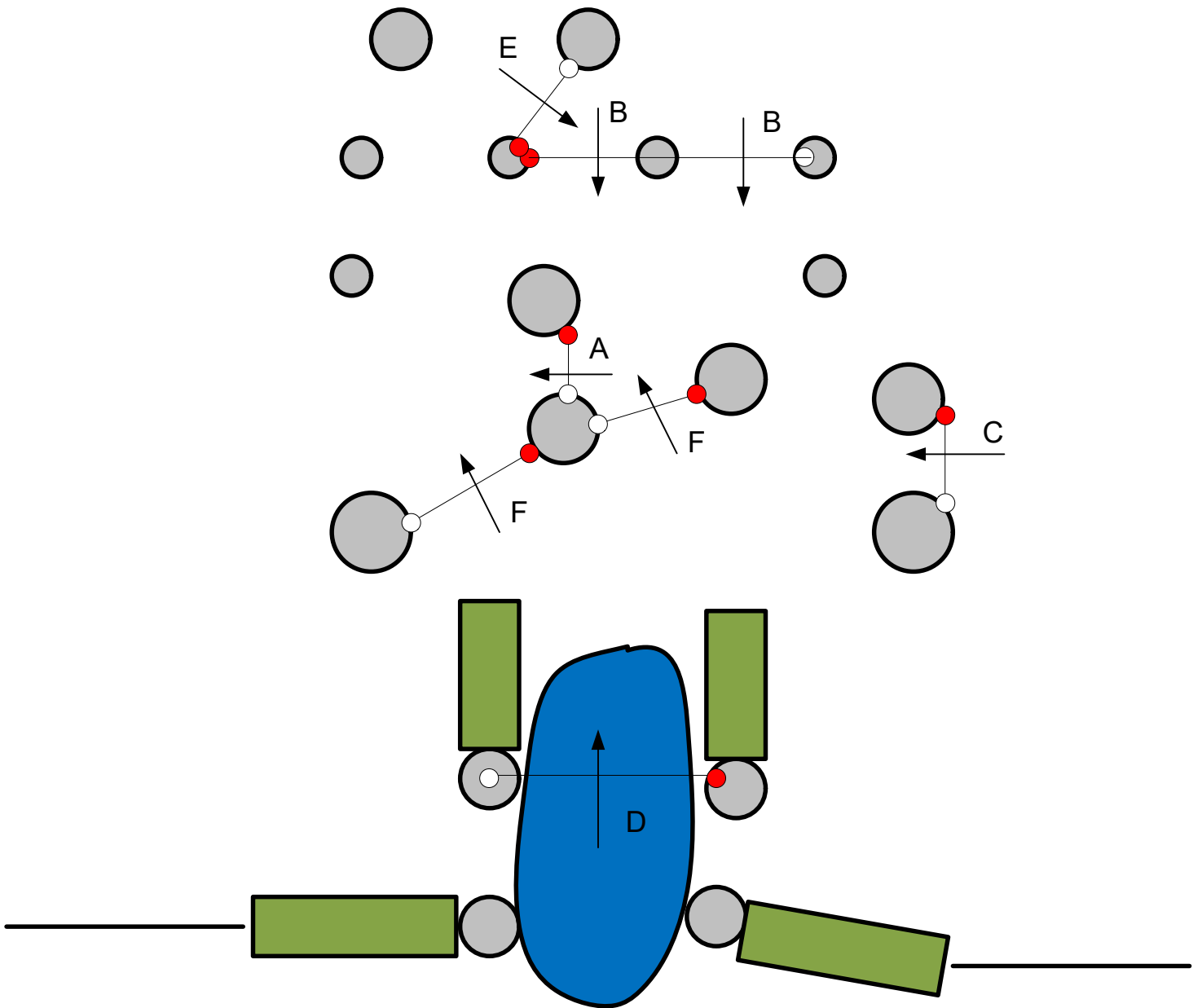

CAI*** Bühl
07. - 11.06.23

Children CAICh: A-D

Obstacle 6: Sparkasse Bühl

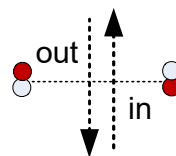
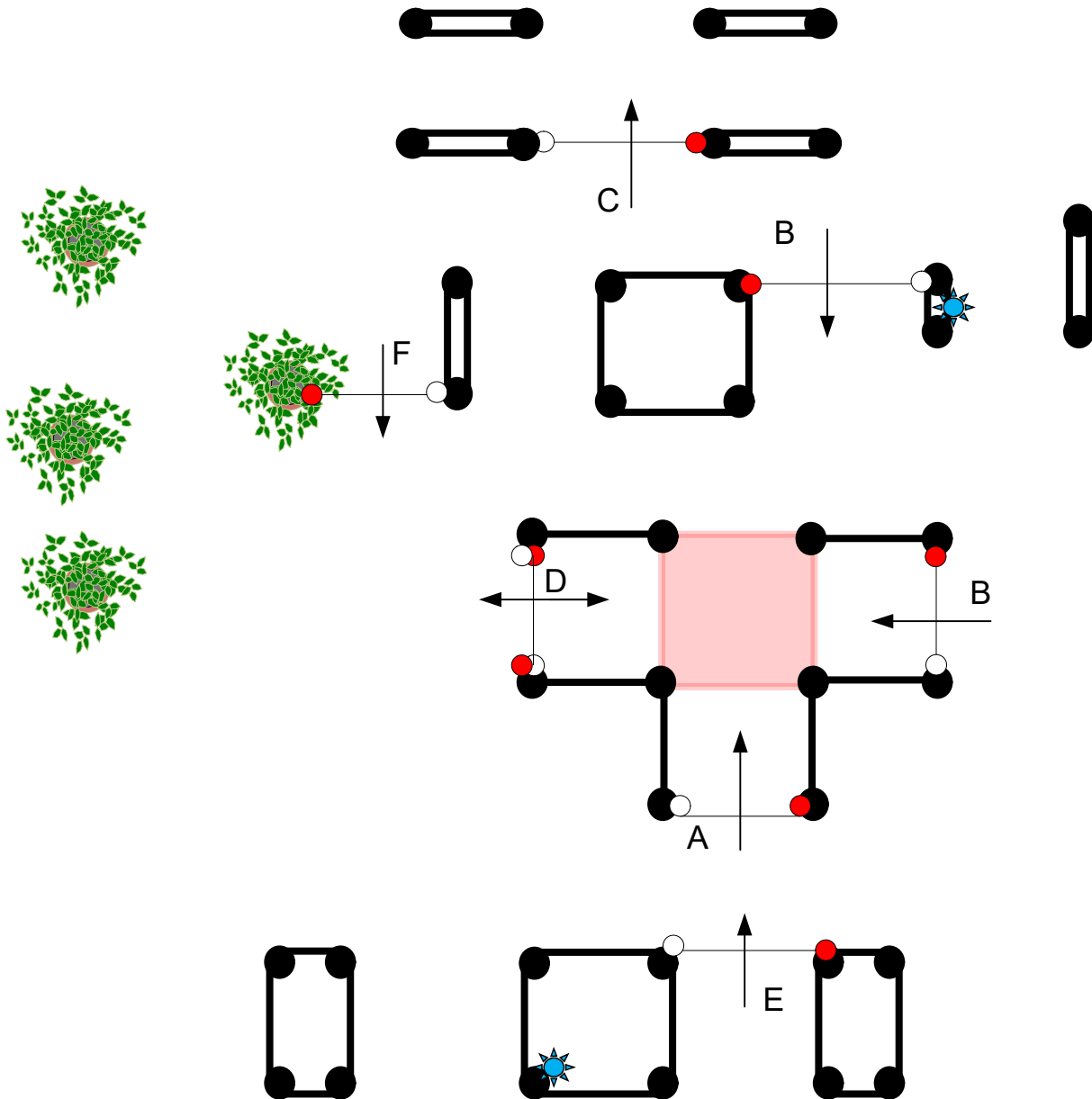

Children CAICh: A-D

 2 Knock Downs

Michael Mayer | 
Course Designer michael-mayer.ch
CD-Ass.: U.Bernhard

Obstacle 7: Druckerei Stolzenberger

